

# Systems Configurations

## BVX-100 Series Fume Extraction

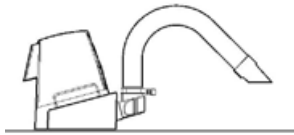

**BVX-101**  
On bench with  
exhaust Arm

### Other possible configurations:

- On bench with plenum (**BVX-101S**)
- On shelf with Arm & inverted adapter (**BVX-IADT**)
- With under bench bracket (**BVX-BCK**)
- On the floor with flexible Arm kit (**BVX-ARM-K1**)

## BVX-200 Series Fume Extraction

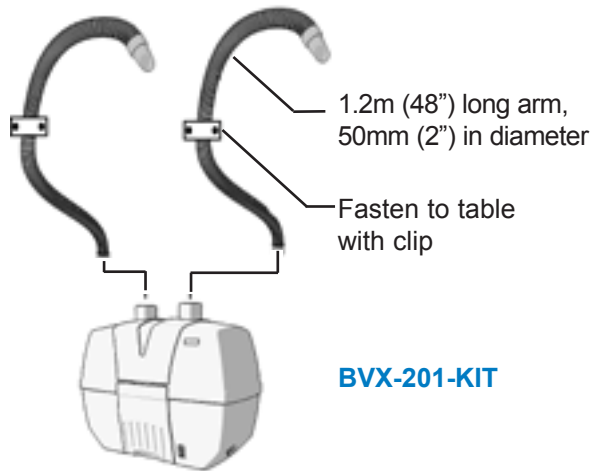

**BVX-201-KIT**

### Other possible configurations:

- **BVX-200** with flexible hoses (BVX-Arm-K1) & BVX Arms. The flexible hoses offer greater spacing between arms.) For longer hoses you can order individual components ([www.Metcal.com](http://www.Metcal.com))
- **BVX-200** with flexible hoses & Omniflex Arms



EA1122



EA1124



EA1126

# Systems Configurations

## MFX-2200 Series Fume Extraction

### Pre/HEPA/Gas with Exhaust Arms

#### MFX-2200C-A or MFX-2200C-D

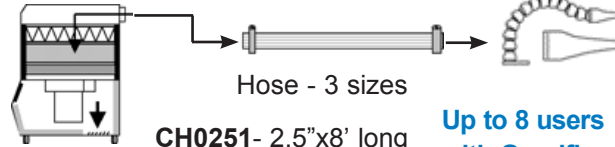

Hose - 3 sizes

- CH0251- 2.5"x8' long
- CH0251- 2.5"x8' long
- CH0251- 2.5"x8' long

Up to 8 users  
with Omniflex  
Arm EA1124  
tapered nozzle

### Other possible configurations:

- Up to 4 users with Omniflex Arm **EA1122** rectangular nozzle & **EA1126** large hood per unit
- Up to 8 users with **BVX-ARM** per unit (BVX-ARM-K2: BVX Arm ESD with nozzle, mounting plate and C-Clamps)

*All Arms are supplied with mounting bracket and two C-Clamps.*

## BTX-208 Tip Extraction Duct Layout

The **BTX-208** can provide fume extraction for up to 8 stations. Select a duct connection kit based on the number of stations, the layout and the length of ducting.

### Connection Kits:

- **BTX-CK2-25** - For 2-4 stations w/2.5m (8') long hose
- **BTX-CK4-50** - For 4-8 stations w/5m (16') long hose
- **BTX-CK4-75** - For 4-8 stations w/7.5m (25') long hose

Download our Guide to Safely Manage Solder Fumes In the Workplace and our Fume Extraction Planning Guide at: [www.OKInternational.com/Metcal/](http://www.OKInternational.com/Metcal/)

# METCAL

[www.Metcal.com](http://www.Metcal.com)

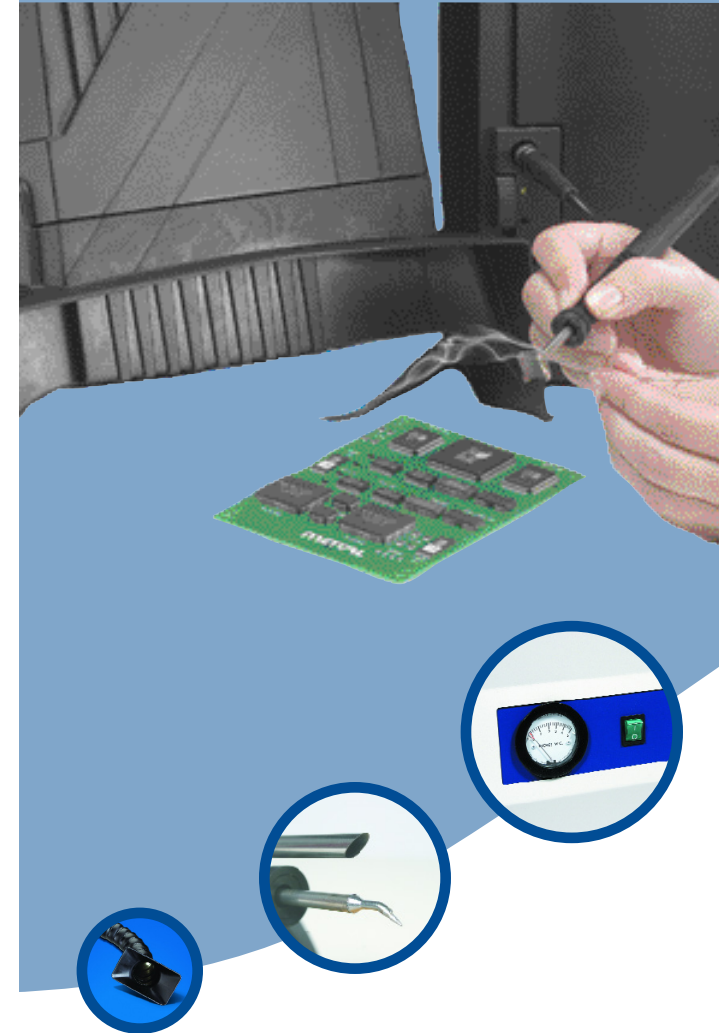

## Fume Extraction Product Guide

Single & Multi Users

# METCAL

# Which System Should You Buy?

## VOLUME EXTRACTION

### PARTICULATE Extractors

### GAS Extractors

### REPLACEMENT FILTERS

Particulate = \* Gas = \*\*

## BVX-100 Series

### SINGLE USER

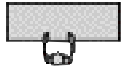

■ **BVX-101** - Bench-Top Arm System

■ **BVX-101S** - Bench-Top Plenum System

■ **BVX-103** - Bench-Top Arm System

■ **BVX-103S** - Bench-Top Plenum System

*All BVX-100 units have lights to indicate when the filter needs to be replaced*

**FP-BVX** \* / \*\*

Pre-filter

**FM-BVX** \*

Main Filter (Combined HEPA/Gas)

**FG-BVX** \*\*

Deep Bed Gas

## BVX-200 Series

### TWO USERS

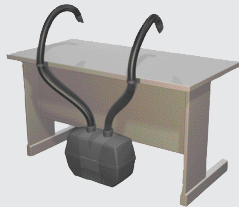
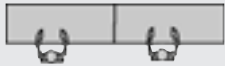
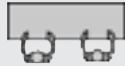

■ **BVX-201-KIT1** - Filter unit with 2 BVX arms (760mm), 2 hoses (1.8m), table brackets, and C-clamps

■ **BVX-201-KIT** - Filter unit with 2 flexible arms 1,5m long

■ **BVX-201** - Filter unit only, for 2 stations (arms not included)

■ **BVX-203** - Filter unit for 2 stations (arms not included)

*All BVX-200 units have an easy on/off remote switch and an audible alarm to indicate when filters need to be replaced*

**FP-BVX200** \* / \*\*

Pre-filter

**FM-BVX200** \*

Main Filter HEPA Carbon

**FG-BVX200** \*\*

Deep Bed Gas Filter

## MFX-2200 Series

### MULTI USERS up to 8

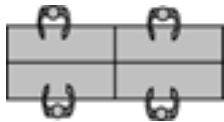

■ **MFX-2200C-A** - Particle Fume Extraction System with analog control

■ **MFX-2200C-D** - Particle Fume Extraction System with digital control

■ **MFX-2200G-A** - Gas Fume Extraction System with analog control

■ **MFX-2200G-D** - Gas Fume Extraction System with digital control

**FIL22P030** \* for **MFX-2200C**  
Pre-filter Pleated 60% efficiency

**FIL22H070** \* for **MFX-2200C**  
Combination Filter HEPA/Carbon

**FIL22P040** \*\* for **MFX-2200G**  
Pre-filter Pleated 85% efficiency

**FIL22H010** \*\* for **MFX-2200G**  
Gas Filter Cartridge 11Kg (25lbs)

**FIL22H020** \*\* for **MFX-2200G**  
Carbon Refill Kit 11Kg 25lbs)

## TIP EXTRACTION

## BTX-200 Series

### MULTI USERS up to 8

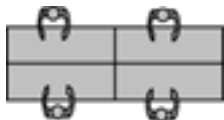

■ **BTX-208** - Filter Unit for 8 Tip Extraction Stations

Full range of Connection Kits and Tip Extraction Iron Adapter Kit available at [www.Metcal.com](http://www.Metcal.com)

**Universal Iron Adapter Clip - BTX-UC01**

Not Applicable



**FP-BVX200** \*

Pre-filter

**FM-BVX200** \*

Main Filter HEPA Carbon