

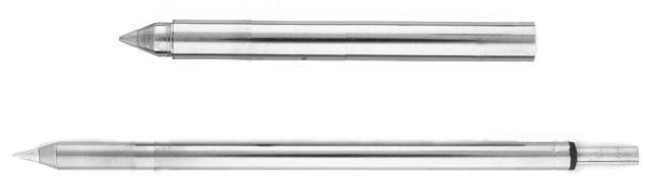

Soldering / Desoldering / Rework Tips and Cartridges

SELECTION GUIDE

For MX- / MFR- and PS-900 Solder Systems

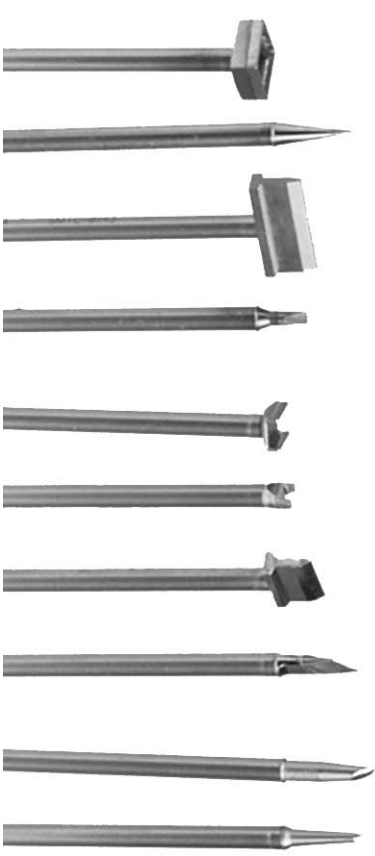

Content - *(Click on required tip-serie to go direct to the relevant page)*

Metcal MX STTC Soldering Cartridges - Power	1
Metcal MX STTC Soldering Cartridges	2 - 4
Metcal MX UFTC UltraFine Soldering Cartridges	5 - 6
Metcal MX SMTC Rework Cartridges	7 - 11
Metcal MX PTTC Tweezer Cartridges	13
Metcal MX TATC Talon Cartridges	14
Metcal MX STDC Desoldering Cartridges	15
Metcal SP/MFR SSC Soldering Cartridges	16 - 18
Metcal MFR/PS-900 SxV Soldering Tip	19 - 22
Metcal MFR/PS-900 CxV Soldering ReworkTip	23
Metcal MFR SxP Soldering & Rework Cartridge	24 - 26
Metcal MFR RxP Rework Cartridge	27- 29
Metcal MFR TxP Tweezer Cartridge.....	30
Metcal MFR DxP Desoldering Tip	31
SmartHeat Technology	32



ALL METCAL TIPS AND CARTRIDGES ARE
POWERED BY SMARTHEAT® TECHNOLOGY

SmartHeat® Technology = Variable Power / Fixed Temperature

► See page 29 for full explanation



CHISEL

STTC SOLDERING CARTRIDGES

Compatible with: MX-500 to MX-5200 Systems / MX-RM3E and MX-H1-AV hand-pieces

	<p>STTC-125P STTC-825P</p>	<p>Chisel, Cone 30° P = Optimised geometry for best thermal performance 1.0 x 6.5 mm (.04" x .25")</p>
	<p>STTC-525 STTC-025 STTC-125 STTC-825</p>	<p>Chisel, Cone 30° 1.0 x 9.1 mm (.04" x .33")</p>
	<p>STTC-138P STTC-838P</p>	<p>Chisel, Cone 30° P = Optimised geometry for best thermal performance 1.5 x 6.0 mm (.06" x .24")</p>
	<p>STTC-538 STTC-038 STTC-138 STTC-838</p>	<p>Chisel, Cone 30° 1.5 x 9.9 mm (.06" x .39")</p>
	<p>STTC-599 STTC-099 STTC-199 STTC-899</p>	<p>Chisel, Bent 30°, Cone 30°, 1.5 x 11.9 mm (.06" x .47")</p>
	<p>STTC-137P STTC-837P</p>	<p>Chisel, Cone 30° P = Optimised geometry for best thermal performance 1.78 x 6.0 mm (.07" x .24")</p>
	<p>STTC-537 STTC-037 STTC-137 STTC-837</p>	<p>Chisel, Cone 30° 1.78 x 9.9 mm (.07" x .39")</p>
	<p>STTC-598 STTC-098 STTC-198 STTC-898</p>	<p>Chisel Bent 30°, Cone 30° 1.78 x 9.9 mm (.07" x .39")</p>
	<p>STTC-542 STTC-042 STTC-142 STTC-842</p>	<p>Long Reach Chisel, Cone 60° 1.78 x 16 mm (.07" x .63")</p>
	<p>STTC-514 STTC-014 STTC-114</p>	<p>Chisel, Cone 45° 2.0 x 4.7 mm (.08" x .19")</p>

STTC Soldering Cartridges

5 = 500 Series and 0 = 600 Series for temperature sensitive applications - 1 = 700 Series for most standard applications.
8 = 800 Series for Ceramic and high thermal demand applications.



STTC SOLDERING CARTRIDGES

Compatible with: MX-500 to MX-5200 Systems / MX-RM3E and MX-H1-AV hand-pieces

CHISEL

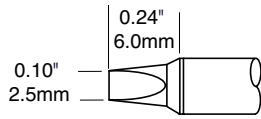

STTC-136P
STTC-836P

Chisel, Cone 30°
P = Optimised geometry for best thermal performance
2.5 x 6.0 mm (.10" x .24")

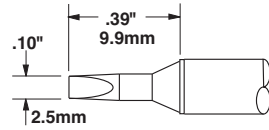

STTC-536
STTC-036
STTC-136
STTC-836

Chisel, Cone 30°
2.5 x 9.9 mm (.10" x .39")

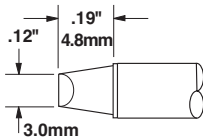

STTC-513
STTC-013
STTC-113
STTC-813

Chisel, Cone 90°
3.0 x 4.8 mm (.12" x .19")

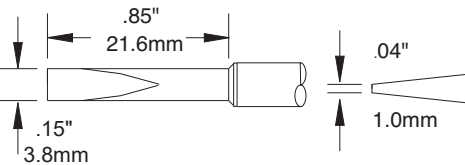

STTC-520
STTC-020
STTC-120
STTC-820

Long Reach Chisel, Cone 12°
3.8 x 21.6 mm (.15" x .85")

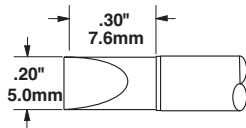

STTC-517
STTC-017
STTC-117
STTC-817

Large Chisel
5.0 x 7.6 mm (.20" x .30")

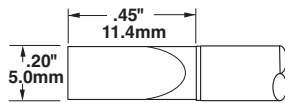

STTC-565
STTC-065
STTC-165
STTC-865

Large Chisel
5.0 x 11.4 mm (.20" x .45")

CONICAL

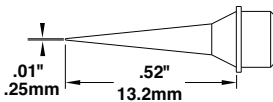

STTC-590
STTC-090
STTC-190
STTC-890

Fine, Long Reach, Conical
0.25 x 13.2 mm (.01" x .52")

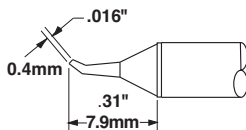

STTC-526
STTC-026
STTC-126
STTC-826

Conical Sharp, Bent 30°
0.4 x 7.9 mm (.016" x .31")

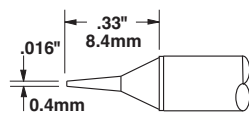

STTC-522
STTC-022
STTC-122
STTC-822

Conical Sharp
0.4 x 8.4 mm (.016" x .33")

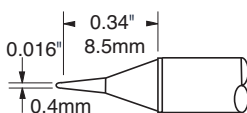

STTC-145P
STTC-845P

Conical Sharp
P = Optimised geometry for best thermal performance
0.4 x 8.5 mm (.016" x .34")



STTC Soldering Cartridges



CONICAL

STTC SOLDERING CARTRIDGES

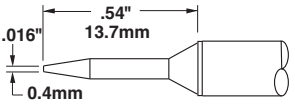
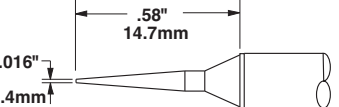
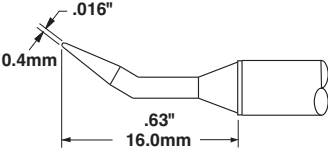
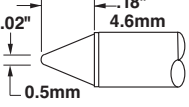
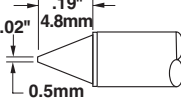
Compatible with: MX-500 to MX-5200 Systems / MX-RM3E and MX-H1-AV hand-pieces

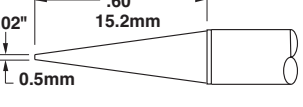
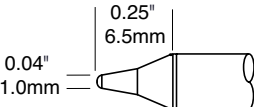
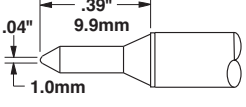
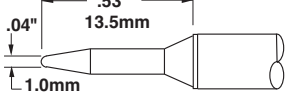
	<p>STTC-506 STTC-006 STTC-106 STTC-806</p>	<p>Conical Sharp 0.4mm x 13.7mm (.016" x .54")</p>
	<p>STTC-545 STTC-045 STTC-145 STTC-845</p>	<p>Conical Sharp 0.4 x 14.7 mm (.016" x .58")</p>
	<p>STTC-540 STTC-040 STTC-140 STTC-840</p>	<p>Conical Sharp, Bent 30° Long Reach 0.4 x 16 mm (.016" x .63")</p>
	<p>STTC-511 STTC-011 STTC-111</p>	<p>Conical, 0.5 x 4.6 mm (.02" x .18")</p>
	<p>STTC-516 STTC-016 STTC-116 STTC-816</p>	<p>Conical, 0.5 x 4.8 mm (.02" x .19")</p>
	<p>STTC-544 STTC-044 STTC-144 STTC-844</p>	<p>Conical Sharp, Bent 30° Long Reach 0.5 x 14.5 mm (.02" x .57")</p>
	<p>STTC-543 STTC-043 STTC-143 STTC-843</p>	<p>Conical Sharp 0.5 x 15.2 mm (.02" x .6")</p>
	<p>STTC-101P STTC-801P</p>	<p>Conical P = Optimised geometry for best thermal performance 1.0 x 6.5 mm (.04" x .25")</p>
	<p>STTC-531 STTC-031 STTC-131</p>	<p>Conical 1.0 x 9.9 mm (.04" x .39")</p>
	<p>STTC-501 STTC-001 STTC-101</p>	<p>Conical 1.0 x 13.5 mm (.04" x .53")</p>

5 = 500 Series and 0 = 600 Series for temperature sensitive applications - 1 = 700 Series for most standard applications.
8 = 800 Series for Ceramic and high thermal demand applications.



STTC SOLDERING CARTRIDGES

Compatible with: MX-500 to MX-5200 Systems / MX-RM3E and MX-H1-AV hand-pieces

CONICAL		STTC-507 STTC-007 STTC-107	Conical, Long Reach, 1 x 16.7 mm (.04" x .66")
		STTC-541 STTC-041 STTC-141 STTC-841	Conical, Bent 30° Long Reach, 1.3 x 21.8 mm (.05" x .86")
BEVEL		STTC-546 STTC-046 STTC-146 STTC-846	Conical, (Bevel/L) 60° x 1 mm, (ø x L) 0.5 x 14.2 mm (.04" x .56")
		STTC-147P STTC-847P	Conical, (Bevel/L) 60° x 1.78 mm (ø x L) 0.83 x 6.4 mm (.07" x .25")
		STTC-535 STTC-035 STTC-135	Conical, Bevel 30° (ø x L) 1.78 x 9.9 mm (.07" x .39")
		STTC-505 STTC-005 STTC-105	Conical, Bevel 30° (ø x L) 1.78 x 11.7 mm (.07" x .46")
		STTC-547 STTC-047 STTC-147 STTC-847	Conical, Long Reach, (Bevel/L) 60° x 1.78 mm, (ø x L) 0.83 x 14.2 mm

5 = 500 Series and 0 = 600 Series for temperature sensitive applications - 1 = 700 Series for most standard applications.
 8 = 800 Series for Ceramic and high thermal demand applications.

STTC-124
 Neigung 30°,
 Neigungslänge
 1,0 mm

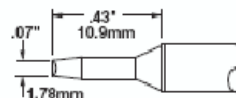
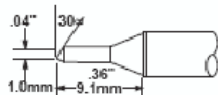

STTC-X04
 Meißel 90°
 1,78mm (0,07")

STTC-197
 Halbrund, konisch
 zulaufend für
 Coaxkabel, Ø 3,6 mm

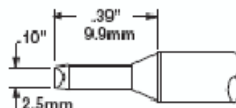
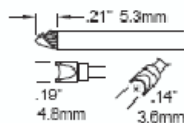

STTC-X33
 Meißel 90°
 2,5mm (0,10")

STTC-170
 Lötstempel,
 Ø 4,8 mm

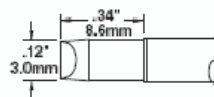
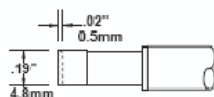

STTC-X03*
 Chisel 90°
 .12" (3.0mm)

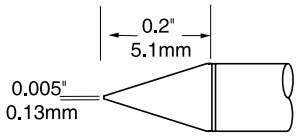
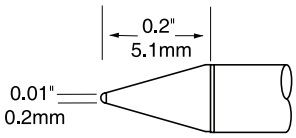
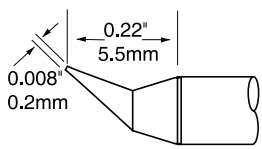
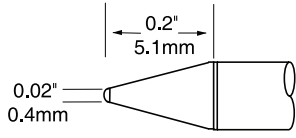
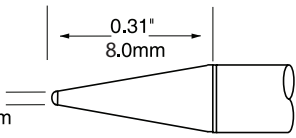
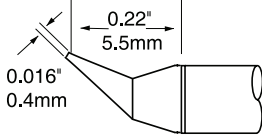
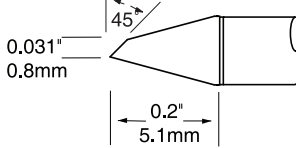
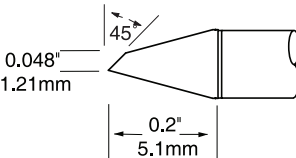

Compatible with MX-500 to MX-5200 Systems and MX-H2-UF hand-piece

<p>UFTC ULTRAFINE SOLDERING CARTRIDGES</p>			
<p style="writing-mode: vertical-rl; transform: rotate(180deg);">CONICAL</p>		<p>UFTC-7CN01</p>	<p>Conical, (ø x L) 0.13 x 5.1 mm (.005" x .20")</p>
		<p>UFTC-7CN02</p>	<p>Conical, (ø x L) 0.2 x 5.1 mm (.01" x .20")</p>
		<p>UFTC-7CNB02</p>	<p>Conical Bent, (ø x L) 0.2 x 5.5 mm (0.01" x .22")</p>
		<p>UFTC-7CN04</p>	<p>Conical, (ø x L) 0.4 x 5.1 mm (.02" x 0.20")</p>
		<p>UFTC-7CNL04</p>	<p>Conical Long, (ø x L) 0.4 x 8 mm (.02" x .31")</p>
		<p>UFTC-7CNB04</p>	<p>Conical Bent, (ø x L) 0.4 x 5.5 mm (.02" x .22")</p>
<p style="writing-mode: vertical-rl; transform: rotate(180deg);">HOOF</p>		<p>UFTC-7DRH408</p>	<p>Hoof Micro, Bevel 45° (ø x L) 0.8 x 5.1 mm (.03" x .20")</p>
		<p>UFTC-7DHR412</p>	<p>Hoof Micro, Bevel 45° (ø x L) 1.2 x 5.1 mm (.048" x .20")</p>

7 = 700 Series for most standard applications



Compatible with MX-500 to MX-5200 Systems and MX-H2-UF hand-piece

CHISEL

UFTC ULTRAFINE SOLDERING CARTRIDGES		
	UFTC-7CH06	Chisel 0.6 x 5.1 mm (.024" x .20")
	UFTC-7CHL06	Chisel Long 0.6 x 9 mm (.024" x .35")
	UFTC-7CH08	Chisel 0.8 x 5.1 mm (.03" x .2")
	UFTC-7CHL08	Chisel Long 0.8 x 9 mm (.03" x .35")
	UFTC-7CH12	Chisel 1.2 x 5.1 mm (.05" x .20")

7 = 700 Series for most standard applications

Compatible with: MX-500 to MX-5200 Systems, MX-RM3E and MX-H1-AV hand-pieces.
All dimensions shown are in mm (inches)

SMTC REWORK CARTRIDGES

SLOT

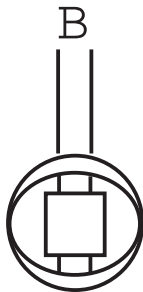
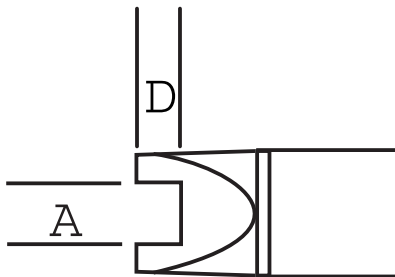

	A	D	B	SMT TYPE
SMTC-505 SMTC-005 SMTC-105	1.7 (.068)	1.27 (.05)	2.5 (.10)	SOT-32
SMTC-596 SMTC-096 SMTC-196	1.78 (.070)	1.02 (.040)	1.02 (.040)	Chip 0402, 0603
SMTC-588 SMTC-088 SMTC-188	2.03 (.080)	1.52 (.60)	1.27 (.050)	Chip 0402, 0603, 0805
SMTC-501 SMTC-001 SMTC-101	2.3 (.090)	1.8 (.070)	1.3 (.050)	Chip 0805
SMTC-502 SMTC-002 SMTC-102	3.6 (.14)	1.8 (.07)	1.5 (.06)	Chip 1206,1210
SMTC-132	3.81 (.150)	2.54 (.10)	2.41 (.095)	Chip Box B EIA SOPM-3528
SMTC-536 SMTC-036 SMTC-136	4.8 (.190)	4.06 (.16)	2.8 (.110)	Chip Box B EIA SOPM-4532
SMTC-503 SMTC-003 SMTC-103	4.83 (.190)	1.91 (.075)	2.03 (.080)	Chip 1812

SMTC Rework Cartridges

5 = 500 Series & 0 = 600 Series for temperature sensitive applications. 1 = 700 Series for most standard applications.
8 = 800 Series for Ceramic and high thermal demand applications.

Compatible with: MX-500 to MX-5200 Systems, MX-RM3E and MX-H1-AV hand-pieces
All dimensions shown are in mm (inches)

TUNNEL

SMTC REWORK CARTRIDGES

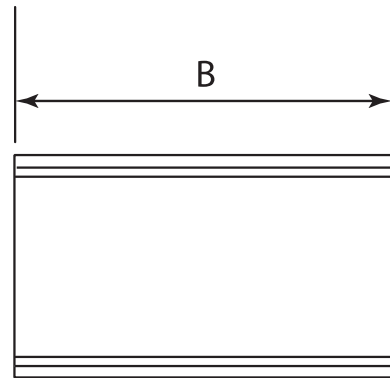
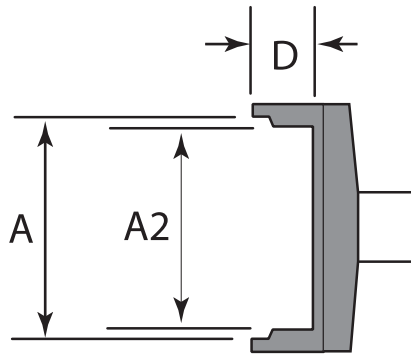

	A	A2	D	B	SMT TYPE
SMTC-004 SMTC-104	5.08 (.20)	5.08 (.20)	2.3 (.90)	4.32 (.17)	SOIC-8
SMTC-006 SMTC-106	5.08 (.20)	5.08 (.20)	2.3 (.90)	10.16 (.40)	SOIC-14,16
SMTC-0142 SMTC-1142	5.18 (.204)	5.18 (.204)	2.54 (.100)	8.89 (.350)	SOIC-14
SMTC-047 SMTC-147	8.51 (.335)	8.51 (.335)	5.08 (.200)	6.35 (.250)	DPAC
SMTC-126	8.64 (.340)	8.0 (.315)	1.88 (.074)	18.8 (.740)	SOJ-28, SOM-32
SMTC-007 SMTC-107	9.53 (.375)	9.53 (.375)	3.20 (.125)	18.3 (.720)	SOIC-28
SMTC-009 SMTC-109	9.53 (.375)	9.53 (.375)	3.18 (.125)	15.75 (.620)	SOIC-24
SMTC-010 SMTC-110	9.53 (.375)	9.53 (.375)	3.20 (.125)	13.20 (.520)	SOIC-20
SMTC-040 SMTC-140	11.43 (.450)	10.40 (.410)	1.90 (.075)	25.9 (1.02)	SOJ-40, SOM-32

5 = 500 Series & 0 = 600 Series for temperature sensitive applications. 1 = 700 Series for most standard applications.
8 = 800 Series for Ceramic and high thermal demand applications.

SMTC Rework Cartridges

Compatible with: MX-500 to MX-5200 Systems, MX-RM3E and MX-H1-AV hand-pieces
All dimensions shown are in mm (inches)

SMTC REWORK CARTRIDGES

QUAD

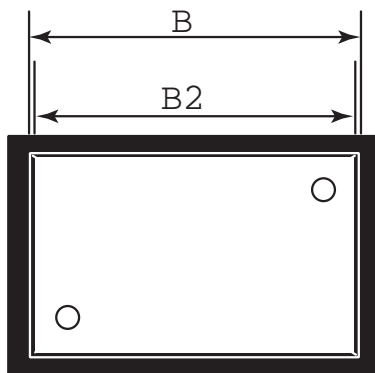
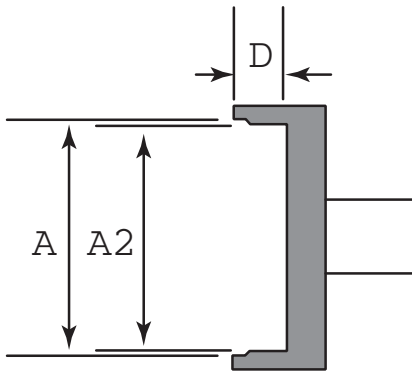

	A	A2	D	B	B2	SMT TYPE
SMTC-0121 SMTC-1121	8.38 (.330)	8.38 (.330)	2.54 (.100)	8.38 (.330)	8.38 (.330)	SQFP 48 (EIJA)
SMTC-0112 SMTC-1112	10.16 (.400)	9.14 (.360)	3.80 (.150)	10.16 (.400)	9.14 (.360)	PLCC 20
SMTC-0120 SMTC-1120	11.18 (.440)	11.18 (.440)	2.54 (.100)	11.18 (.440)	11.18 (.440)	SQFP 64 (EIJA)
SMTC-1159	12.19 (.480)	11.18 (.440)	2.79 (.110)	13.21 (.520)	12.19 (.480)	TQFP 44
SMTC-013 SMTC-113	12.70 (.500)	11.56 (.455)	3.80 (.150)	12.70 (.500)	11.56 (.455)	PLCC 28
SMTC-116	12.70 (.500)	11.43 (.450)	3.80 (.150)	15.24 (.600)	13.97 (.550)	PLCC 32
SMTC-1132	13.34 (.525)	12.32 (.485)	2.79 (.110)	13.34 (.525)	12.32 (.485)	TQFP 80
SMTC-0118 SMTC-1118	15.49 (.610)	14.48 (.570)	2.79 (.110)	15.49 (.610)	14.48 (.570)	VQFP 100 (EIJA)
SMTC-043 SMTC-143	16.51 (.650)	16.51 (.650)	3.30 (.130)	22.48 (.885)	22.48 (.885)	QFP 100 Rectangular
SMTC-014 SMTC-114	17.78 (.700)	16.76 (.660)	3.80 (.150)	17.78 (.700)	16.76 (.660)	PLCC 44
SMTC-117	20.32 (.800)	19.30 (.760)	3.80 (.150)	20.32 (.800)	19.30 (.760)	PLCC 52
SMTC-118	25.27 (.995)	19.30 (.760)	3.80 (.150)	25.27 (.995)	19.30 (.760)	PLCC 68
SMTC-144	26.42 (1.040)	26.42 (1.040)	3.30 (.130)	26.42 (1.040)	26.42 (1.040)	QFP 100 Square

5 = 500 Series & 0 = 600 Series for temperature sensitive applications. 1 = 700 Series for most standard applications.
8 = 800 Series for Ceramic and high thermal demand applications.

Metcal SMTC High Mass Rework Blade Cartridges

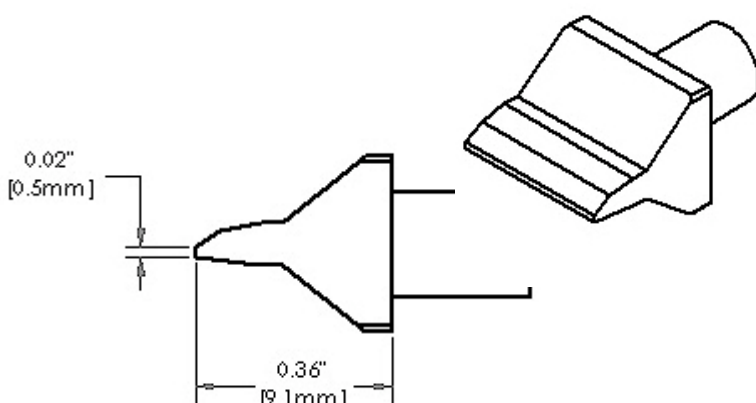

These massive Blade Tips were developed for safer pad cleaning process by increasing mass on tip without increasing temperature. The range includes sizes with a width of 5, 10, 15, 25 and 35 mm, and is available in 600, 700 and 800 series temperature range.

Replace **x** by either **0**, **1** or **8**:

0 = 600 Series for temperature sensitive applications

1 = 700 Series for most standard applications.

8 = 800 Series for Ceramic and high thermal demand applications.

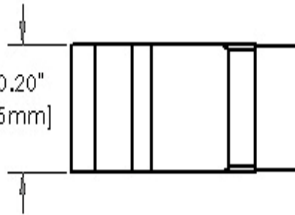
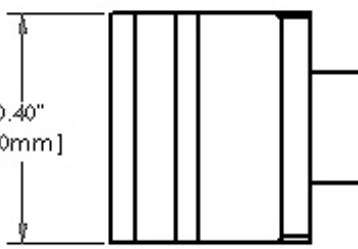
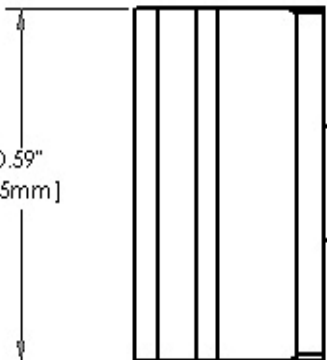
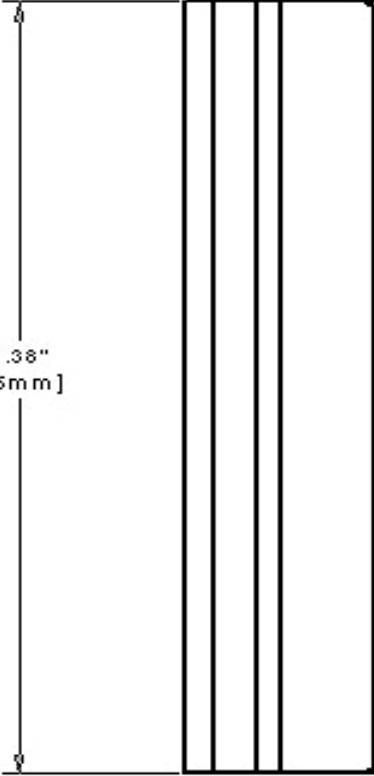
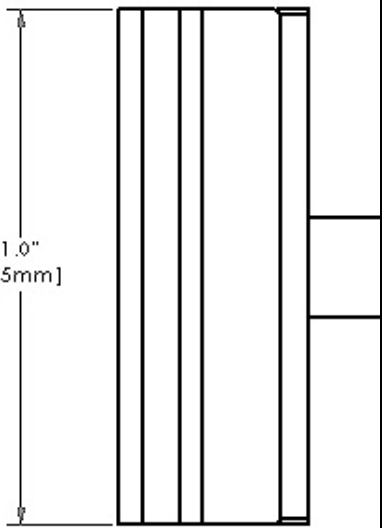
Part Number		Part Number	
SMTC- x BL050		SMTC- x BL100	
SMTC- x BL150		SMTC- x BL350	
SMTC- x BL250		<p>NOTE: These tips have been designed specifically, for use with the MX-5000/5200 systems. Due to the lower available power for the MX-500, blades wider than 15 mm are not suitable for use with this system.</p>	

Compatible with: MX-500 to MX-5200 Systems, MX-RM3E and MX-H1-AV hand-pieces

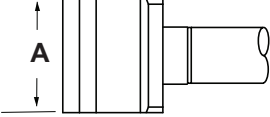
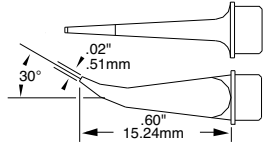
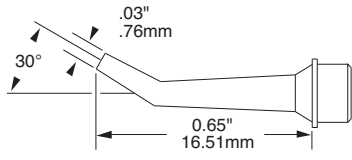
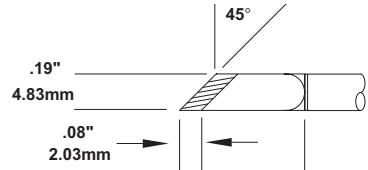
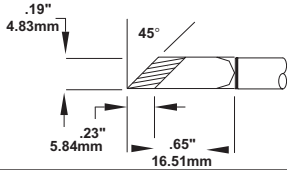
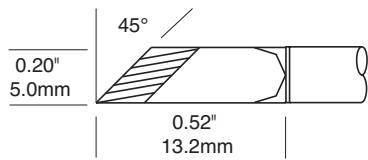
SMTC REWORK CARTRIDGES		A	BLADE TYPE	BLADE
	SMTC-064 SMTC-164	5 mm (.20")	Pad Cleaning	
	SMTC-560 SMTC-060 SMTC-160 SMTC-860	10 mm (.40")	Pad Cleaning	
	SMTC-561 SMTC-061 SMTC-161 SMTC-861	15.75 mm (.62")	Pad Cleaning	
	SMTC-562 SMTC-062 SMTC-162 SMTC-862	22 mm (.86")	Pad Cleaning	
	SMTC-5172 SMTC-0172 SMTC-1172 SMTC-8172	Hook Long, 30° Bent, 0.5 mm x 15.24 mm (.02"x.06")	HOOK & CONICAL	
	SMTC-5171 SMTC-0171 SMTC-1171 SMTC-8171	Concave, 30° Bent, 0.76 x 16.51 mm (.03"x .65")		
	SMTC-5161 SMTC-0161 SMTC-1161	Knife 45° - Tinned Area Length 2.03 mm (.08") 4.8 x 16.51 mm (.18"x .65")	KNIFE	
	SMTC-5173 SMTC-1173 SMTC-8173	Knife 45° - Increased tinned Area Length 5.84 mm (.23") 4.8 x 16.51 mm (.18"x .65")	SMTC Rework Cartridges	
	STTC-1173P STTC-8173P	Knife 45° - Increased tinned Area Length 5.84 mm (.23") 5.0 x 13.2 mm (.20" x .52")		

5 = 500 Series & 0 = 600 Series for temperature sensitive applications. 1 = 700 Series for most standard applications. 8 = 800 Series for Ceramic and high thermal demand applications.

SMTC REWORK CARTRIDGES

Compatible with: MX-500 and MX-5000 Systems, MX-RM3E and MX-H1-AV hand-pieces

HOOF

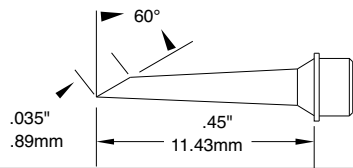

SMTC-5175
SMTC-0175
SMTC-1175
SMTC-8175

Micro Hoof, Bevel 60°,
(ø x L) 0.89 x 11.43 mm
(.035"x.45")

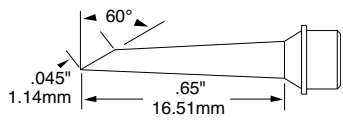

SMTC-5174
SMTC-0174
SMTC-1174

Micro Hoof, Bevel 60°,
Long Reach, (ø x L)
1.14 x 16.51mm (.045"x.65")

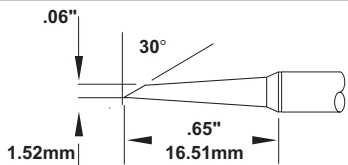

SMTC-5167
SMTC-0167
SMTC-1167

Hoof, Bevel 30°, Long Reach,
(ø x L) 1.5 x 16.51mm
(.06"x.65")

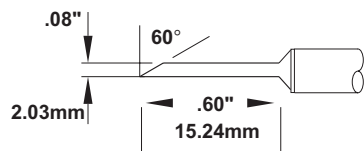

SMTC-5169
SMTC-0169
SMTC-1169

Hoof, Bevel 60°, Long Reach,
(ø x L) 2 x 15.24 mm (
.08" x .60")

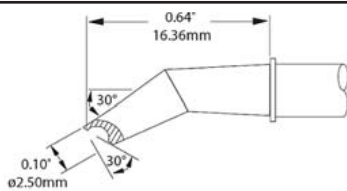

SMTC-0183
SMTC-1183

Hoof, Concave, 30° Bent,
(ø x L) 2.5 x 16.36 mm
(.01" x .64")

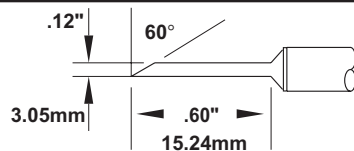

SMTC-5170
SMTC-0170
SMTC-1170

Hoof, Bevel 60°, Long Reach,
(ø x L) 3 x 15.24 mm
(.12" x .60")

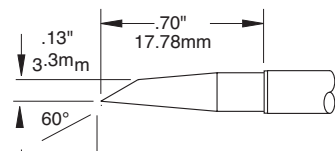

SMTC-5147
SMTC-0147
SMTC-1147
SMTC-8147

Hoof, Bevel 60°, Long Reach,
(ø x L) 3.3 x 17.78 mm
(.13" x .70")

WAVE HOOF

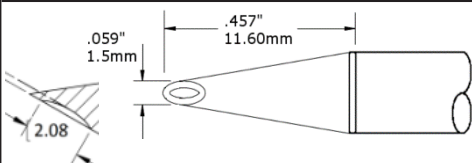

SMTC-5184
SMTC-0184
SMTC-1184
SMTC-8184

Concave WAVE Hoof,
(Bevel/L) 60° x 3 mm,
(ø x L) 1.5 x 11.6 mm

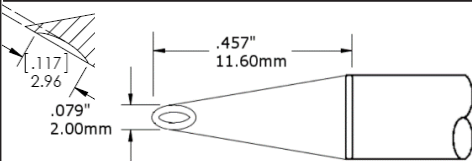

SMTC-5185
SMTC-0185
SMTC-1185
SMTC-8185

Concave WAVE Hoof,
(Bevel/L) 60° x 4 mm,
(ø x L) 2.0 x 11.6 mm

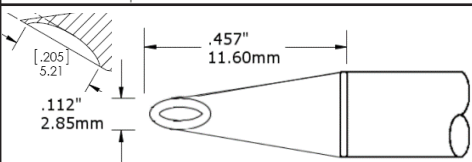

SMTC-5185
SMTC-0185
SMTC-1185
SMTC-8185

Concave WAVE Hoof,
(Bevel/L) 60° x 6 mm,
(ø x L) 3.0 x 11.6 mm

SMTC Rework Cartridges

Metcal Cartridges



Compatible with: MX-5200 to 500 Systems and MX-PTZ Precision Tweezers hand-piece. Sold per pair.

PTTC TWEEZER CARTRIDGES			
CONICAL		PTTC-601 PTTC-701 PTTC-801	Conical 0.4 x 19 mm (.016" x .75")
		PTTC-701B PTTC-801B	Conical, Bent 30° 0.4 x 14.3 mm (.016" x .56")
BLADE		PTTC-602 PTTC-702 PTTC-802	Blade, Thickness 1 mm (.04"), 1.3 x 16.5 mm (.05" x .65")
		PTTC-603 PTTC-703 PTTC-803	Blade, Thickness 1 mm (.04"), 2 x 16.5 mm (.08" x .65")
		PTTC-608B PTTC-708B PTTC-808B	Blade, Bent 30° 3.5 x 12.1 mm (0.12" x .48")
		PTTC-604 PTTC-704 PTTC-804	Blade, Bent 22°, Thickness 0.7 mm (.28"), 6.35 x 12.7 mm (.25" x .50")
		PTTC-605 PTTC-705 PTTC-805	Blade, Bent 22°, Thickness 0.7 mm (.28"), 16 x 12.7 mm (.63" x .50")
PTTC Tweezer Cartridges		PTTC-606 PTTC-706 PTTC-806	Blade, Bent 22°, Thickness 0.7 mm (.28"), 20.5 x 12.7 mm (.80" x .50")
		PTTC-607 PTTC-707 PTTC-807	Blade, Bent 22°, Thickness 0.7 mm (.28"), 28 x 12.7 mm (1.1" x .50")

6 = 600 Series for temperature sensitive applications. 1 = 700 Series for most standard applications.
8 = 800 Series for Ceramic and high thermal demand applications.

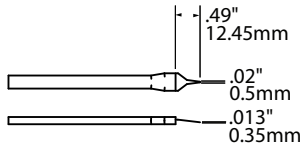
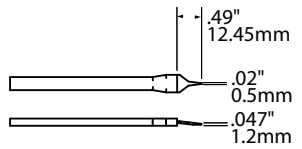
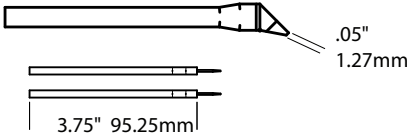
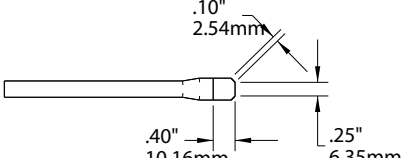
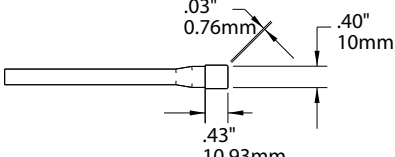
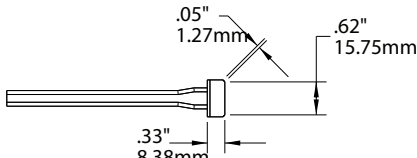
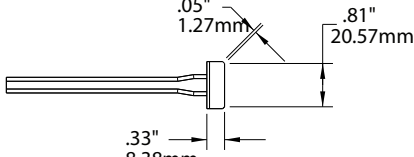
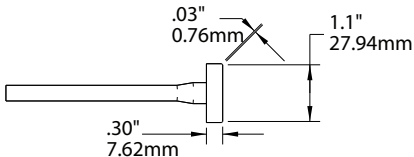

TATC TALON Tweezer CARTRIDGES

Compatible with: MX-5200 to 500 Systems and MX-TALON hand-piece.
Sold per pair.

	<p>TATC-609</p>	<p>Fine Point, Thickness 0.35 mm (.0137") 0.5 x 12.45 mm (.02" x .49")</p>
	<p>TATC-601</p>	<p>Fine Point, Thickness 1.2 mm (.047") 0.5 x 12.45 mm (.02" x .49")</p>
	<p>TATC-608</p>	<p>Dual Side, Angled Point, 1.27 mm (.05")</p>
	<p>TATC-602</p>	<p>Blade 6.35 x 10.16 mm (.25" x .40")</p>
	<p>TATC-605</p>	<p>Blade 10 x 10.93 mm (.394" x .43")</p>
	<p>TATC-603</p>	<p>Blade 15.75 x 8.38 mm (.62" x .33")</p>
	<p>TATC-604</p>	<p>Blade 20.57 x 8.38 mm (.81" x .33")</p>
	<p>TATC-606</p>	<p>Blade 27.94 x 7.62 mm (1.1" x .30")</p>

0 = 600 Series for temperature sensitive applications.

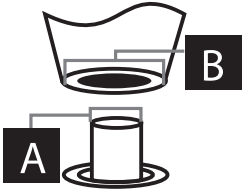
Compatible with: MX-500 to MX-5200 Systems, MX-DS1 Desoldering hand-piece
 All dimensions shown are in mm (inches)

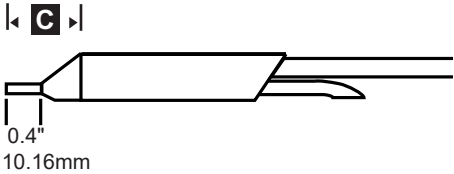
STDC DESOLDER CARTRIDGES		A	B	C	TYPE
  <p>Standard</p>	STDC-102 STDC-802	0.64 (.025)	1.40 (.055)	11.43 (.45)	Standard
	STDC-103 STDC-803	0.76 (.029)	1.68 (.066)	11.17 (.44)	Standard
	STDC-104 STDC-804	1.02 (.04)	1.78 (.07)	10.92 (.43)	Standard
	STDC-105 STDC-805	1.27 (.05)	2.03 (.08)	10.66 (.42)	Standard
	STDC-106 STDC-806	1.52 (.06)	2.29 (.09)	10.41 (.41)	Standard
	STDC-107 STDC-807	2.41 (.09)	3.18 (.12)	9.14 (.36)	Standard
	 <p>Long Reach</p>	STDC-703L STDC-803L	0.76 (.03)	1.68 (.06)	21.33 (.84)
STDC-704L STDC-804L		1.02 (.04)	1.79 (.07)	21.08 (.83)	Long Reach
STDC-705L STDC-805L		1.27 (.05)	2.03 (.08)	20.82 (.82)	Long Reach

1 = 700 Series (standard length) and 7 = 700 Series (long reach) for most standard applications.
 8 = 800 Series for Ceramic and high thermal demand applications.



CHISEL

SSC SOLDERING CARTRIDGES		Compatible with: Metcal SP200, OKi MFR-1160 Systems, Metcal SP-HC1 and OKi MFR-H6-SSC hand-pieces
	<p>SSC-671A SSC-771A</p>	<p>Chisel 1.0 x 9.1mm (.04" x .36")</p>
	<p>SSC-625A SSC-725A</p>	<p>Chisel 30° 1.0 x 11mm (.04" x .43")</p>
	<p>SSC-638A SSC-738A</p>	<p>Chisel 30° 1.5 x 10 mm (.06" x .40")</p>
	<p>SSC-637A SSC-737A</p>	<p>Chisel 30° 1.78 x 9.9 mm (.07" x .40")</p>
	<p>SSC-672A SSC-772A</p>	<p>Chisel 1.78 x 9.9 mm (.07"x .39")</p>
	<p>SSC-642A SSC-742A</p>	<p>Long Reach Chisel 60° 1.78 x 16 mm (.07" x .63")</p>
	<p>SSC-670A SSC-770A</p>	<p>Long Reach Chisel 1.78 x 16.5 mm (.07" x .65")</p>
	<p>SSC-636A SSC-736A</p>	<p>Chisel 30° 2.5 x 9.9 mm (.10" x .39")</p>
	<p>SSC-613A SSC-713A</p>	<p>Chisel 90° 3.0 x 7.6 mm (.12" x .30")</p>
	<p>SSC-646A SSC-746A</p>	<p>Long Reach Chisel 3.0 x 16.5 mm (.12" x .65")</p>

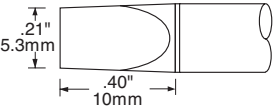
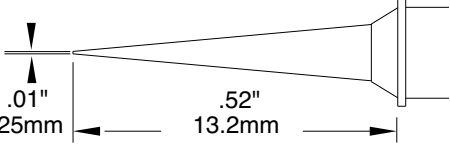
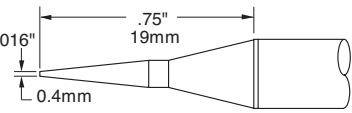
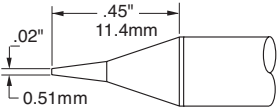
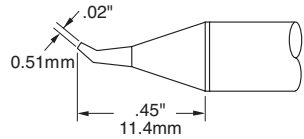
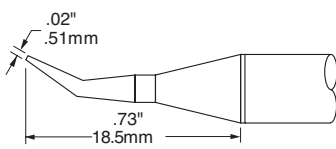
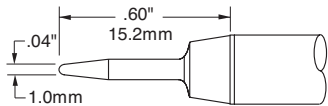
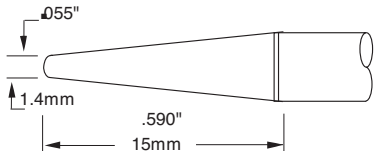

CONICAL

SSC SOLDERING CARTRIDGES		Compatible with: Metcal SP200, OKi MFR-1160 Systems, Metcal SP-HC1 and OKi MFR-H6-SSC hand-pieces
	SSC-617A SSC-717A	Extra Large Chisel 5.3 x 10 mm (.21" x .40")
	SSC-690A SSC-790A	Long Reach Micro Fine Conical 0.25 x 13.2 mm (.01" x .52")
	SSC-645A SSC-745A	Conical Sharp Long Reach 0.4 x 19 mm (.016" x .75")
	SSC-622A SSC-722A	Conical Sharp 0.51 x 11.4 mm (.02" x .45")
	SSC-626A SSC-726A	Conical Sharp Bent 30° 0.51 x 11.4 mm (.02" x .45")
	SSC-654A SSC-754A	Conical Sharp Bent 30° Long Reach 0.5 x 18.5 mm (.02" x .73")
	SSC-601A SSC-701A	Conical Sharp 1.0 x 15.2 mm (.04" x .60")
	SSC-674A SSC-774A	Conical 1.4 x 15 mm (.055" x .590")

6 = 600 Series for temperature sensitive applications - 7 = 700 Series for most standard applications.

SSC Soldering Cartridges



SSC SOLDERING CARTRIDGES		Compatible with: Metcal SP200, OKi MFR-1160 Systems, Metcal SP-HC1 and OKi MFR-H6-SSC hand-pieces	
HOOF		SSC-667A SSC-767A	Mini-Hoof 1.27 x 17.8 mm (.05" x .70")
		SSC-639A SSC-739A	Hoof 2.3 x 17.8 mm (.016" x .70")
KNIFE		SSC-661A SSC-761A	Knife, Bevel 45° 4.5 x 16.25 mm (.18" x .64")
		SSC-673A SSC-773A	Knife, Bevel 45° Increased tinned area 6,1mm 5.1 x 16.25 mm (.24" x .64")
BEVEL		SSC-647A SSC-747A	Bevel 60°, Length 1.78 mm, Tip Length 14.2 mm (.07" x .56")

6 = 600 Series for temperature sensitive applications - 7 = 700 Series for most standard applications.



Compatible with: PS-900, MFR-1120, MFR-2220, MFR-2222 Systems, PS-HC3 and MFR-H2-ST2 hand-pieces, PS-CA3 and MFR-CA3 Coil Assemblies

CHISEL

SxV SOLDERING TIPS		
	<p>SFV-CH10A STV-CH10A SCV-CH10A</p>	<p>Chisel 1.0 x 18.3 mm (.04" x .719")</p>
	<p>SFV-CH10AR STV-CH10AR SCV-CH10AR</p>	<p>Chisel 1.0 x 13.7 mm (.04" x .54")</p>
	<p>SFV-CH10 STV-CH10 SCV-CH10</p>	<p>Chisel 1.0 x 11 mm (.04" x .43")</p>
	<p>SFV-CH15A STV-CH15A SCV-CH15A</p>	<p>Chisel 1.5 x 11.3 mm (.06" x .44")</p>
	<p>SFV-CH15AR STV-CH15AR SCV-CH15AR</p>	<p>Chisel 1.5 x 13.4 mm (.06" x .528")</p>
	<p>SFV-CHB15 STV-CHB15 SCV-CHB15</p>	<p>Chisel Bent 30° 1.5 x 12.2 mm (.06" x .48")</p>
	<p>SFV-CH18AR STV-CH18AR SCV-CH18AR</p>	<p>Chisel 1.8 x 13.4 mm (.07" x .528")</p>
	<p>SFV-CH20 STV-CH20 SCV-CH20</p>	<p>Chisel 2.0 x 11 mm (.08" x .43")</p>
	<p>SFV-CH24A STV-CH24A SCV-CH24A</p>	<p>Chisel Long Reach 2.4 x 18.3 mm (.094" x .719")</p>
	<p>SFV-CH25AR STV-CH25AR SCV-CH25AR</p>	<p>Chisel 2.5 x 13.4 mm (.10" x .528")</p>

SxV Soldering Tips

Compatible with: PS-900, MFR-1120, MFR-2220, MFR-2222 Systems,
PS-HC3 and MFR-H2-ST2 hand-pieces, PS-CA3 and MFR-CA3 Coil Assemblies

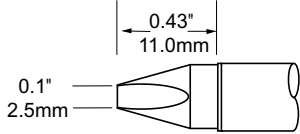
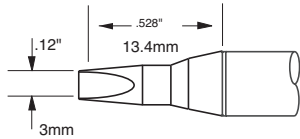
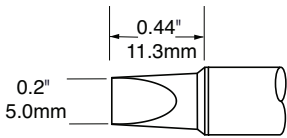
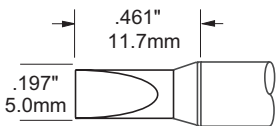
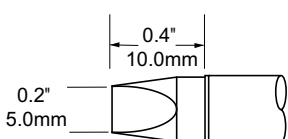
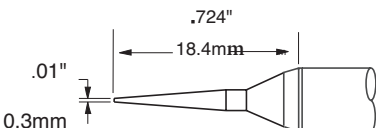
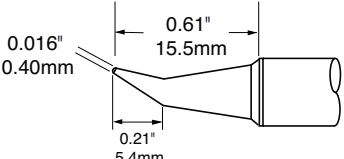
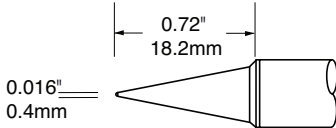
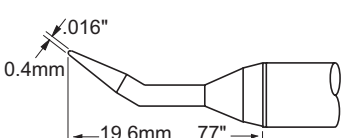
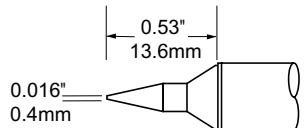
SxV SOLDERING TIPS		
CHISEL		SFV-CH25 STV-CH25 SCV-CH25 Chisel 2.5 x 11mm (.10" x .43")
		SFV-CH30AR STV-CH30AR SCV-CH30AR Chisel 3.0 x 13.4 mm (.12" x .528")
		SFV-CH50A STV-CH50A SCV-CH50A Chisel 5.0 x 11.3 mm (.20" x .44")
		SFV-CH50AR STV-CH50AR SCV-CH50AR Chisel 5.0 x 11.7 mm (.197" x .461")
		SFV-CH50 STV-CH50 SCV-CH50 Chisel 5.0 x 10 mm (.20" x .4")
CONICAL		SFV-CNL03AR STV-CNL03AR SCV-CNL03AR Conical Long Reach 0.3 x 18.4 mm (.01" x .724")
		SFV-CNB04A STV-CNB04A SCV-CNB04A Conical Bent Long Reach 0.4 x 15.5 mm (.016" x .61")
		SFV-CN05A STV-CN05A SCV-CN05A Conical Long Reach 0.4 x 18.2 mm (.016" x .72")
		SFV-CNB04AR STV-CNB04AR SCV-CNB04AR Conical Bent 0.4 x 19.6 mm (.016" x .77")
		SFV-CNL04 STV-CNL04 SCV-CNL04 Conical 0.4 x 13.6 mm (.016" x .53")

F = FR4 / Fiber Glass, for most standard applications T = Temperature Sensitive C = Ceramic for high thermal demand applications.

Compatible with: PS-900, MFR-1120, MFR-2220, MFR-2222 Systems,
PS-HC3 and MFR-H2-ST2 hand-pieces, PS-CA3 and MFR-CA3 Coil Assemblies

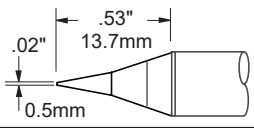
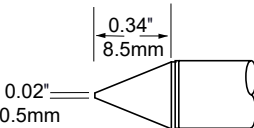
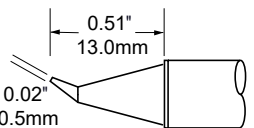
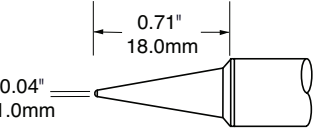
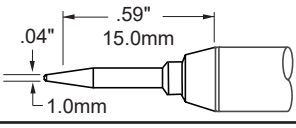
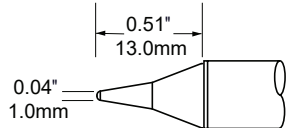
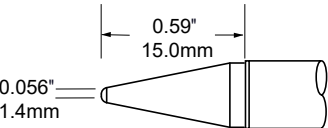
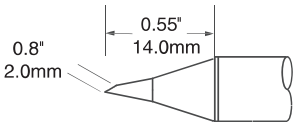
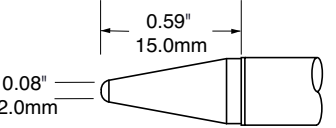
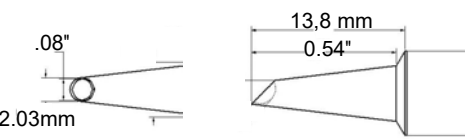
CONICAL	SxV SOLDERING TIPS		
		SFV-CN05AR STV-CN05AR SCV-CN05AR	Conical 0.5 x 13.7 mm (.02" x .53")
		SFV-CN05 STV-CN05 SCV-CN05	Conical 0.5 x 8.5 mm (.02" x .34")
		SFV-CNB05 STV-CNB05 SCV-CNB05	Conical Bent 0.5 x 13 mm (.02" x .51")
		SFV-CNL10A STV-CNL10A SCV-CNL10A	Conical Long Reach 1.0 x 18 mm (.04" x .71")
		SFV-CNL10AR STV-CNL10AR SCV-CNL10AR	Conical Long Reach 1.0 x 13.7 mm (.04" x .54")
		SFV-CNL10 STV-CNL10 SCV-CNL10	Conical Long Reach 1.0 x 13 mm (.04" x .51")
		SFV-CNL14 STV-CNL14 SCV-CNL14	Conical Long Reach 1.4 x 15 mm (.056" x .59")
		SFV-DRH20 STV-DRH20 SCV-DRH20	Conical Bevel 2.0 x 14 mm (.08" x .55")
		SFV-CNL20 STV-CNL20 SCV-CNL20	Conical Long Reach 2.0 x 14 mm (.08" x .59")
	SFV-WV20 STV-WV20 SCV-WV20	Conical, Wave Hoof 45°, 2.0 x 13.8 mm (.08" x .54")	

Compatible with: PS-900, MFR-1120, MFR-2220, MFR-2222 Systems,
PS-HC3 and MFR-H2-ST2 hand-pieces, PS-CA3 and MFR-CA3 Coil Assemblies

HOOF

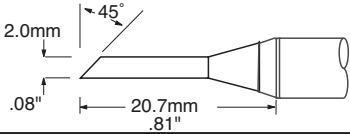
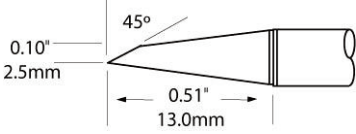
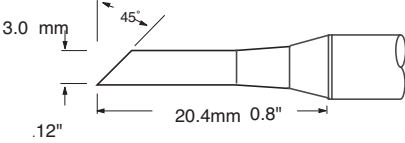
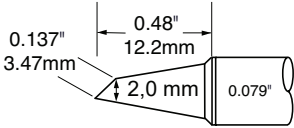
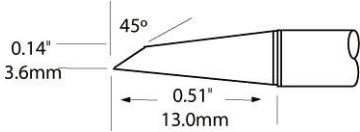
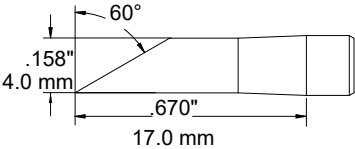
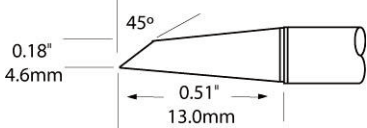
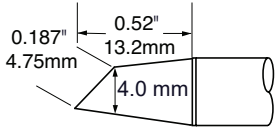
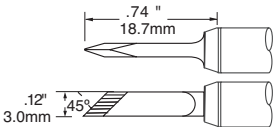
SxV SOLDERING TIPS		
	SFV-DRH420AR STV-DRH420AR SCV-DRH420AR	Hoof, Bevel 45°, Long Reach, 2 x 20.7 mm (.08" x .81")
	SFV-DRH20CP STV-DRH20CP SCV-DRH20CP	Hoof, Bevel 45°, <i>CP = Chrome Plating, face only</i> 2.5 x 13 mm (.10" x .51")
	SFV-DRH430AR STV-DRH430AR SCV-DRH430AR	Hoof, Bevel 45°, Long Reach, 3 x 20.4 mm (.12" x .8")
	SFV-DRH420A STV-DRH420A SCV-DRH420A	Concave Wave Hoof, <i>Optimised for thermal performance</i> 2 x 12.2 mm (.079" x .48")
	SFV-DRH30CP STV-DRH30CP SCV-DRH30CP	Hoof, Bevel 45°, <i>CP = Chrome Plating, face only</i> 3.6 x 13 mm (.14" x .51")
	SFV-DRH640AR STV-DRH640AR SCV-DRH640AR	Hoof, Bevel 60°, Long Reach, 4 x 17 mm (.15" x .67")
	SFV-DRH40CP STV-DRH40CP SCV-DRH40CP	Hoof, Bevel 45°, <i>CP = Chrome Plating, face only</i> 4.6 x 13 mm (.18" x .51")
	SFV-DRH440A STV-DRH440A SCV-DRH440A	Hoof, 4 x 13.2 mm (.187" x .52")
	SFV-DRK30AR STV-DRK30AR SCV-DRK30AR	Knife, Bevel 45°, Long Reach, 3 x 18.7 mm (.12" x .74")

KNIFE

SxV Soldering Tips



KNIFE

SxV SOLDERING TIPS		Compatible with: PS-900, MFR-1120, MFR-2220, MFR-2222 Systems, PS-HC3 and MFR-H2-ST hand-pieces, PS-CA3 and MFR-CA2 Coil Assemblies	
KNIFE		SFV-DRK45A STV-DRK45A SCV-DRK45A	Knife, Bevel 45° <i>Optimised for thermal performance</i> 5.0 x 15.1 mm (.20" x .60")
		SFV-DRK50 STV-DRK50 SCV-DRK50	Knife, Bevel 45° 5.0 x 14 mm (.20" x .55")

F = FR4 / Fiber Glass, for most standard applications T = Temperature Sensitive C = Ceramic for high thermal demand applications.

CxV Rework BLADE TIPS		Compatible with: PS-900, MFR-1120, MFR-2220, MFR-2222 Systems, PS-HC3 and MFR-H2-ST hand-pieces, PS-CA3 and MFR-CA2 Coil Assemblies	
	CFV-BL100 CTV-BL100 CCV-BL100	A	10 mm (.40")
	CFV-BL250 CTV-BL250 CCV-BL250		25 mm (1")
	CFV-BL350 CTV-BL350 CCV-BL350		35 mm (1.4")
	CFV-BL400 CTV-BL400 CCV-BL400		40 mm (1.6")
	CFV-BL500 CTV-BL500 CCV-BL500		50 mm (2")

F = FR4 / Fiber Glass, for most standard applications T = Temperature Sensitive C = Ceramic for high thermal demand applications.



CHISEL

SxP SOLDERING & REWORK CARTRIDGES		Compatible with: MFR-1110, MFR-1161, MFR-2211, MFR-2241 Systems and MFR-H1-SC2 hand-piece	
	<p>SFP-CH10 STP-CH10 SCP-CH10</p>	<p>Chisel, Cone 30° 1.0 x 9.2 mm (.04" x .36")</p>	
	<p>SFP-CH15 STP-CH15 SCP-CH15</p>	<p>Chisel, Cone 30° 1.5 x 10 mm (.06" x .39")</p>	
	<p>SFP-CHB15 STP-CHB15 SCP-CHB15</p>	<p>Chisel, Cone 30°, Bent 1.5 x 12.04 mm (.06" x .474")</p>	
	<p>SFP-CH20 STP-CH20 SCP-CH20</p>	<p>Chisel, Cone 30° 2.0 x 10 mm (.08" x .4")</p>	
	<p>SFP-CHL20 STP-CHL20 SCP-CHL20</p>	<p>Chisel, Cone 60°, Long Reach 2.0 x 16.04 mm (.08" x .632")</p>	
	<p>SFP-CH25 STP-CH25</p>	<p>Chisel, Cone 30° 2.5 x 10 mm (.10" x .39")</p>	
	<p>SFP-CH30 STP-CH30 SCP-CH30</p>	<p>Chisel, Cone 30° 3.0 x 11 mm (.12" x .43")</p>	
	<p>SFP-CH35 STP-CH35 SCP-CH35</p>	<p>Chisel, Cone 30° 3.5 x 11 mm (.12" x .43")</p>	
	<p>SFP-CH50 STP-CH50</p>	<p>Chisel, Cone 30° 5.0 x 7.6 mm (.20" x .3")</p>	

F = FR4 / Fiber Glass, for most standard applications T = Temperature Sensitive C = Ceramic for high thermal demand applications

SxP Soldering and Rework Cartridges

Compatible with: MFR-1110, MFR-1161, MFR-2211, MFR-2241 Systems and MFR-H1-SC2 hand-piece

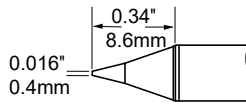
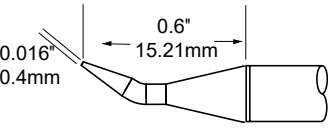
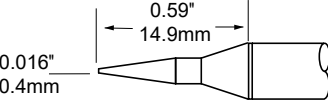
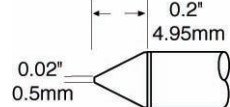
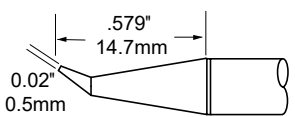
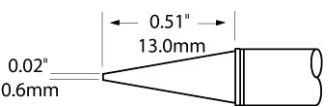
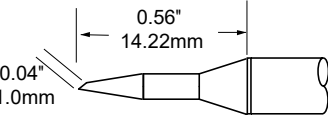
SxP SOLDERING & REWORK CARTRIDGES		
CONICAL		<p>SFP-CN04 STP-CN04 SCP-CN04</p> <p>Conical, (\varnothing x L) 0.4 x 8.6 mm (.016" x .34")</p>
		<p>SFP-CNB04 STP-CNB04 SCP-CNB04</p> <p>Conical, Bent, (\varnothing x L) 0.4 x 15.21 mm (.016" x .6")</p>
		<p>SFP-CNL04 STP-CNL04 SCP-CNL04</p> <p>Conical, Long Reach, (\varnothing x L) 0.4 x 14.9 mm (.016" x .59")</p>
		<p>SFP-CN05 STP-CN05 SCP-CN05</p> <p>Conical, (\varnothing x L) 0.5 x 4.95 mm (.02" x .20")</p>
		<p>SFP-CNB05 STP-CNB05 SCP-CNB05</p> <p>Conical, Bent, Long Reach, (\varnothing x L) 0.5 x 14.7 mm (.02" x .58")</p>
		<p>SFP-CNL06 SCP-CNL06</p> <p>Conical, Long Reach, (\varnothing x L) 0.6 x 13 mm (.023" x .59")</p>
BEVEL		<p>SFP-BLV10 STP-BLV10 SCP-BLV10</p> <p>Bevel 60°, (\varnothing x L) 1.0 x 14.22 mm (.04" x .56")</p>

F = FR4 / Fiber Glass, for most standard applications T = Temperature Sensitive C = Ceramic for high thermal demand applications

Compatible with: MFR-1110, MFR-1161, MFR-2211, MFR-2241 Systems and MFR-H1-SC hand-piece

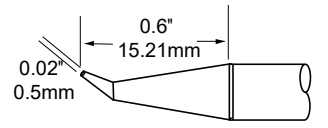
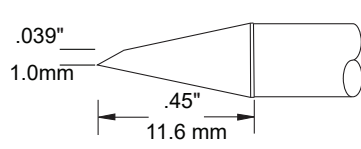
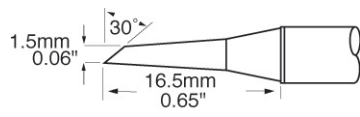
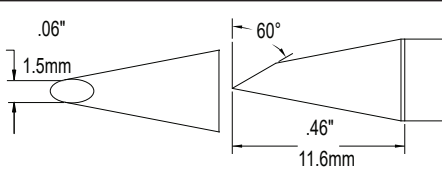
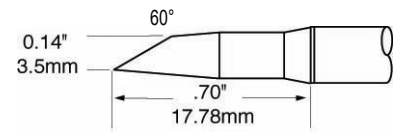
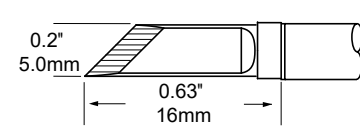
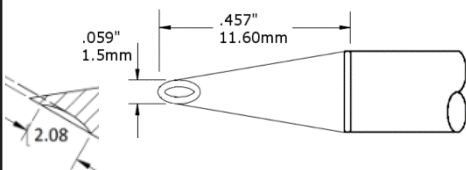
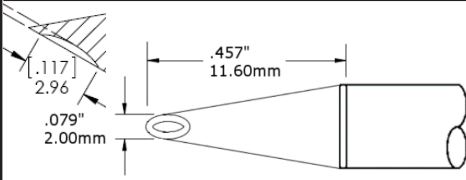
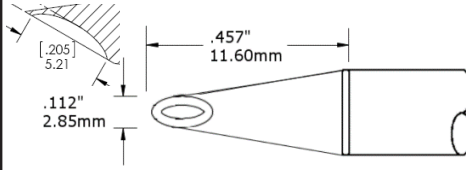
SxP SOLDERING & REWORK CARTRIDGES		
HOOF		<p>SFP-DRH05 STP-DRH05 SCP-DRH05</p> <p>Hoof, (\varnothing x L) 0.5 x 15.21 mm (.02" x .6")</p>
		<p>SFP-DRH610 STP-DRH610 SCP-DRH610</p> <p>Hoof, Bevel 60°, (\varnothing x L) 1.0 x 11.6 mm (.04" x .45")</p>
		<p>SFP-DRH15 STP-DRH15 SCP-DRH15</p> <p>Hoof, Bevel 30°, (\varnothing x L) 1.5 x 16.5 mm (.06" x .65")</p>
		<p>SFP-DRH615 STP-DRH615 SCP-DRH615</p> <p>Hoof, Bevel 60°, (\varnothing x L) 1.5 x 11.6 mm (.06" x .46")</p>
		<p>SFP-DRH35 STP-DRH35 SCP-DRH35</p> <p>Hoof, Bevel 60°, Long Reach, (\varnothing x L) 3.5 x 17.78 mm (.14" x .7")</p>
KNIFE		<p>SFP-DRK50 STP-DRK50 SCP-DRK50</p> <p>Knife, (W x L) 5.0 x 16 mm (.20" x .63")</p>
		<p>SFP-WV15 STP-WV15 SCP-WV15</p> <p>Concave WAVE Hoof, (Bevel/L) 60° x 2,08 mm, (\varnothing x L) 1.5 x 11.6 mm</p>
WAVE-HOOF		<p>SFP-WV20 STP-WV20 SCP-WV20</p> <p>Concave WAVE Hoof, (Bevel/L) 60° x 2,96 mm, (\varnothing x L) 2.0 x 11.6 mm</p>
		<p>SFP-WV30 STP-WV30 SCP-WV30</p> <p>Concave WAVE Hoof, (Bevel/L) 60° x 5.21 mm, (\varnothing x L) 2.85 x 11.6 mm</p>

F = FR4 / Fiber Glass, for most standard applications T = Temperature Sensitive C = Ceramic for high thermal demand applications

SxP Soldering and Rework Cartridges

Compatible with: MFR-1110, MFR-1161, MFR-2211, MFR-2241 Systems and MFR-H1-SC2 hand-piece
All dimensions shown are in mm (inches)

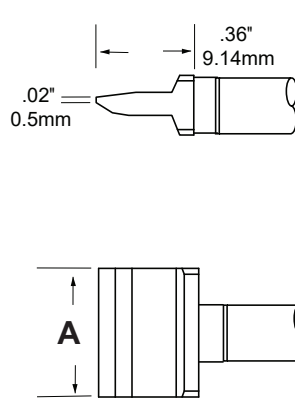
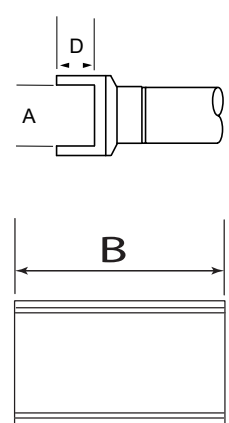
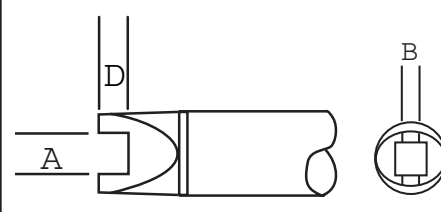
RxP REWORK CARTRIDGES		A	B	D	SMT TYPE	
BLADE		RFP-BL1 RCP-BL1	10 (0.41)	-	-	-
		RFP-BL2 RCP-BL2	15.6 (0.62)	-	-	-
		RFP-BL3 RCP-BL3	22.1 (0.87)	-	-	-
TUNNEL		RFP-DL1 RCP-DL1	5.18 (0.204)	4.32 (0.17)	3.22 (0.127)	Tunnel SOIC-8
		RFP-DL2 RCP-DL2	5.18 (0.204)	4.32 (0.17)	2.29 (.09)	Tunnel SOIC-14-16
		RFP-DL3 RCP-DL3	6.86 (.270)	11.15 (0.44)	2.29 (.09)	Tunnel SOMC-16
SLOT		RFP-SL1 RCP-SL1	2.34 (.092)	1.37 (.054)	1.78 (.07)	0805 Chip Package
		RFP-SL2 RCP-SL2	3.48 (.137)	1.63 (.064)	1.78 (.07)	0805 Chip Package

F = FR4 / Fiber Glass, for most standard applications C = Ceramic for high thermal demand applications.

Compatible with: MFR-1110, MFR-1161, MFR-2211, MFR-2241 Systems and MFR-H1-SC2 hand-piece
All dimensions shown are in mm (inches)

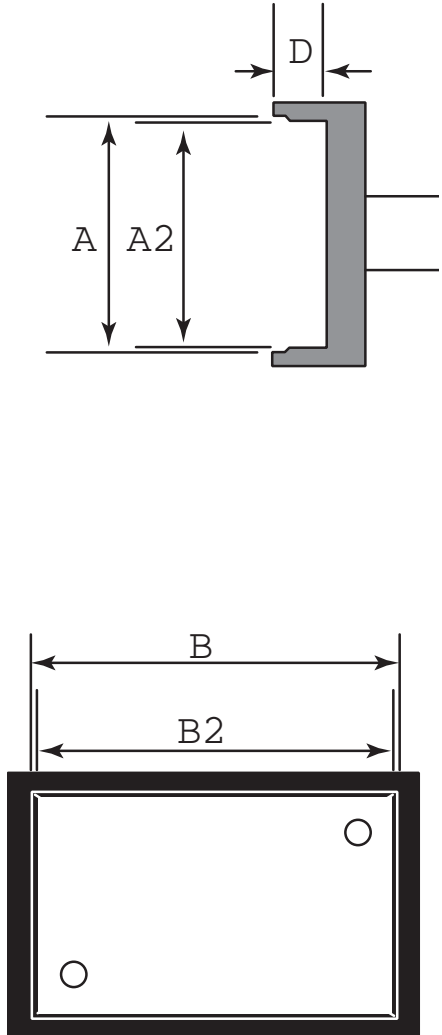



QUAD	RXP REWORK CARTRIDGES		A	A2	D	B	B2	SMT TYPE
			RFP-QD4 RCP-QD4	12.70 (.500)	11.43 (.450)	3.81 (.150)	15.24 (.600)	13.97 (.550)
RFP-QD6 RCP-QD6			17.78 (.700)	16.76 (.660)	3.81 (.150)	17.78 (.700)	16.76 (.660)	PLCC 44
RFP-QD7 RCP-QD7			25.27 (.995)	24.38 (.960)	5.59 (.220)	25.27 (.995)	24.38 (.960)	PLCC 68
RFP-QD10 RCP-QD10			20.32 (.800)	19.30 (.760)	3.81 (.150)	20.32 (.800)	19.30 (.760)	PLCC 52
RFP-QD15 RCP-QD15			13.34 (.525)	12.32 (.485)	2.79 (.110)	13.34 (.525)	12.32 (.485)	TQFP 80
RFP-QD19 RCP-QD19			16.13 (.635)	16.13 (.635)	3.30 (.130)	16.13 (.635)	16.13 (.635)	QFP 44
RFP-QD20 RCP-QD20			16.51 (.650)	16.51 (.650)	3.30 (.130)	22.48 (.885)	22.48 (.885)	QFP 100

F = FR4 / Fiber Glass, for most standard applications C = Ceramic for high thermal demand applications.

Metcal Cartridges

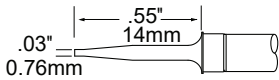

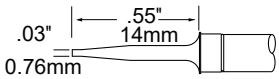
Compatible with: MFR-1140, MFR-2240, MFR2241 Systems and MFR-H4-TW hand-piece.
Sold per pair.

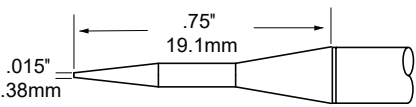
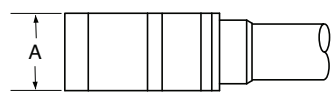
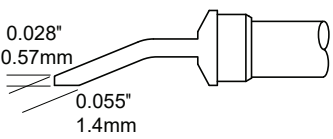
TxP Tweezer Cartridges		
BLADE	 	TFP-BLP1 TTP-BLP1 TCP-BLP1 1.0 x 14 mm (.04" x .55")
	 	TFP-BLP2 TTP-BLP2 TCP-BLP2 2.0 x 14 mm (.08" x .55")
		TFP-CNP1 TTP-CNP1 TCP-CNP1 Conical 0.4 x 19.1 mm (.015" x .75")
HEAVY DUTY		A
		TFP-BLH40 TTP-BLH40 TCP-BLH40 6.35 mm (.25")
		TFP-BLH50 TTP-BLH50 TCP-BLH50 16 mm (.62")
	 	TFP-BLH60 TTP-BLH60 TCP-BLH60 20.5 mm (.81")
		TFP-BLH70 TTP-BLH70 TCP-BLH70 28 mm (1.1")

F = FR4 / Fiber Glass, for most standard applications T = Temperature Sensitive C = Ceramic for high thermal demand applications.

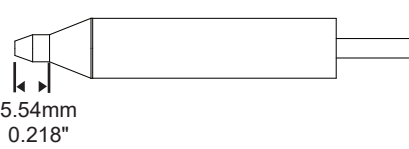
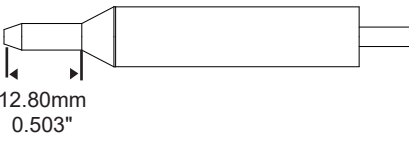
DxP DESOLDERING TIPS		Compatible with: MFR-1350, MFR-1351, MFR-DSX, MFR-DSI, MFR-SDX, MFR-SDI Systems and MFR-H5-DS, MFR-HDS hand-piece. All dimensions shown are in mm (inches)		
		A	B	TYPE
  <p>Standard</p>	DFP-CN2 DCP-CN2	0.67 (.026)	1.80 (.070)	Standard
	DFP-CN3 DCP-CN3	0.79 (.031)	2.05 (.080)	Standard
	DFP-CN4 DCP-CN4	1.05 (.041)	2.30 (.090)	Standard
	DFP-CN5 DCP-CN5	1.31 (.052)	2.65 (.104)	Standard
	DFP-CN6 DCP-CN6	1.55 (.061)	2.85 (.112)	Standard
	DFP-CN7 DCP-CN7	2.44 (.096)	3.65 (.143)	Standard
	 <p>Long Reach</p>	DFP-CNL3 DCP-CNL3	0.79 (.031)	2.05 (.080)
DFP-CNL4 DCP-CNL4		1.05 (.041)	2.30 (.090)	Long Reach
DFP-CNL5 DCP-CNL5		1.31 (.052)	2.65 (.104)	Long Reach

F = FR4 / Fiber Glass, for most standard applications C = Ceramic for high thermal demand applications.

What is Metcal Smartheat® Technology?



OK International is the founder of SmartHeat® Soldering Technology. SmartHeat® senses the exact thermal requirement for each solder joint and responds by delivering the precise amount of thermal energy required to create a reliable connection.

The result is a high degree of control without resorting to higher tip idle temperatures required by conventional heater process technologies. Consequently, the risk of component and board damage is minimized. This is especially important with the greater thermal demands required by lead-free applications.

Conventional Soldering Technology = Fixed Power / Variable Temperature

- ▶ Conventional soldering irons are fixed power systems that store energy in the tip, they don't adjust power in response to thermal demand.
- ▶ The temperature needs to be manually set and adjusted to vary the amount of thermal energy applied, the operator can vary the process.
- ▶ The tip cools as it heats the joint and the heater reheats the tip, often overshooting the set temperature.
- ▶ Conventional soldering systems require calibration.
- ▶ The actual tip temperature can vary widely from set point, slowing the process and causing thermal damage and poor solder joint quality.

SmartHeat® Soldering Technology = Variable Power / Fixed Temperature

- ▶ SmartHeat® tips and cartridges sense the load and instantly deliver the right amount of heat directly to the solder joint.
- ▶ The required solder joint temperature drives the heating process, as opposed to the idle tip temperature setting (as in a conventional iron).
- ▶ Operates at lower safer temperatures. Power is delivered in proportion to the load. SmartHeat® technology eliminates overshoot.
- ▶ No calibration required - saves money and eliminates system down-time.

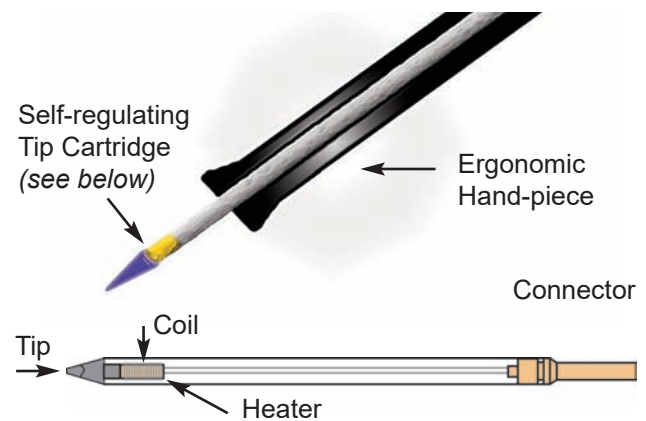
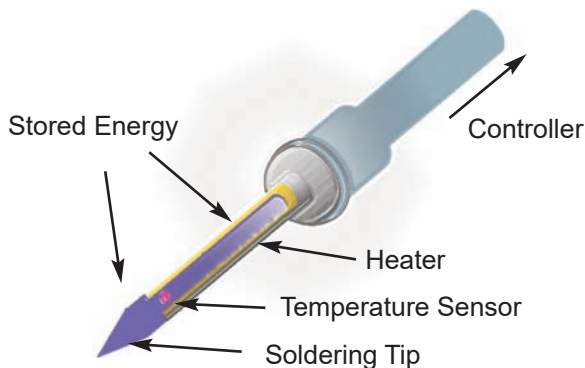

okinternational

OK International Ltd. - UK

*Eagle Close, Chandlers Ford
Hampshire, SO53 4NF, U.K.*

Tel: +44 (0) 23 8048 9100

E-mail: europa-info@metcal.com

Sales Support

Germany

Tel: +49 (0)3222 109 1900

France

Tel: +33 (0)1767 104 03

E-mail: europa-info@metcal.com

Visit our webside

www.metcal.com